

USER'S MANUAL

Universal PCI RS-232 Communication Board

English Version

Third Edition, July 2017



SUNIX Co., Ltd.

Tel : +886-2-8913-1987

Fax: +886-2-8913-1986

[Http://www.sunix.com](http://www.sunix.com)

info@sunix.com

Universal PCI RS-232 Communication Board

User's Manual

Copyright

Copyright© 2017 SUNIX Co., Ltd. All Rights Reserved.

No part of this publication may be reproduced, transcribed, stored in a retrieval system, translated into any language, or transmitted in any form or by any means, photocopying, manual, or otherwise, without prior written permission from SUNIX.

Disclaimer

SUNIX shall not be liable for any incidental or consequential damages resulting from the performance or use of this equipment.

SUNIX makes no representations or warranties regarding the contents of this manual. Information in this manual has been carefully checked for reliability; however, no guarantee is given as to the correctness of this content. In the interest of continued product improvement, this company reserves the right to revise the manual or include change in the specifications of the product described within it at any time without notice and without obligation to notify any person of such revision or changes. The information contained in this manual is provided for general use by the customers.

Trademarks

SUNIX is a registered trademark of SUNIX Group.

All other trademarks or registered marks in this manual belong to their respective owners.

Safety Information

1. Keep this User's Manual for future reference.
2. Always read the safety information carefully.
3. Keep this equipment away from direct sunlight, or in humid or damp places.
4. Do not place this equipment in an unstable position, or on vibrating surface before setting it up.
5. Do not use or place this equipment near magnetic fields, televisions, or radios to avoid electronic interface that affects device performance.

Regulatory Compliance

FCC Conditions

This equipment has been tested and found to comply with Part 15 of the FCC Rules. Operation is subject to the following two conditions:

- (1) This equipment may not cause harmful interference
- (2) This equipment must accept any interference received, including interference that may cause undesired operation.

Important! Changes or modifications not expressly approved by the manufacturer responsible for compliance could void the user's authority to operate the equipment. Use an approved phone set.

CE

This equipment is in compliance with the requirements of the following regulations: EN 55022:

CLASS B

WEEE Information

For EU (European Union) member users: According to the WEEE (Waste electrical and electronic equipment) Directive, do not dispose of this product as household waste or commercial waste. Waste electrical and electronic equipment should be appropriately collected and recycled as required by practices established for your country. For information on recycling of this product, please contact your local authorities, your household waste disposal service or the shop where you purchased the product.

BSMI 聲明

限用物質含有情況標示資訊網站請參考下列網址：<http://www.sunix.com.tw>

操作說明：選擇頁面之產品/型號/文件下載區(RoHS文件)



Table of Contents

Chapter 1 Introduction

1.1 Overview	6
1.2 Package Checklist	6
1.3 Product Features	7
1.4 Product Specifications	8

Chapter 2 Hardware Installation

2.1 Hardware Installation	10
2.2 Pin Assignment.....	11

Chapter 3 Software Installation

3.1 Windows Driver Installation	15
3.2 Windows Driver Uninstallation.....	20
3.3 Linux Driver Installation	21
3.4 Verify Installation	23

Chapter 4 Port Configuration

4.1 Configure Serial Port Settings	25
4.2 Com Port Number Settings.....	26
4.3 Com I/O Resource	26
4.4 FIFO Settings.....	27
4.5 Advanced Settings.....	28

Chapter 5 Appendix

5.1 Troubleshooting	30
5.2 Product Family	32
5.3 Contact Information	36

WHQL Certification Approval

The Designed for Microsoft Windows 32/64-bit operation system WHQL logo identifies products that meet Microsoft's quality standards, SUNIX I/O products carry with this logo and listed on Windows Catalog. WHQL logo includes below operation system version

Microsoft Windows Client: Windows XP / Vista / 7 / 8.x / 10 (X86/X64)

Microsoft Windows Server: Windows 2003 / 2008 / 2012 / 2016 (X64)

1.

Introduction

RS-232 Golden I/O series, a line of Universal PCI Multi-Port Serial Communication Board, is designed for both 3.3V / 5V and 32 / 64-bit PCI Bus with Plug and Play feature. It can be installed in virtually any available PC system and compatible with all major operating systems. Users do not need to manually set jumpers to configure I/O addresses and IRQ locations.

These boards offer independent serial ports for connecting terminals, modems, printers, scanners, cash registers, bar code readers, keypads, numeric displays, electrical scales, data acquisition equipment, and other serial devices for the PC and compatible systems. This board offers a reliable and high performance solution for serial multi-port communications.

The following topics covered in this chapter:

- ◆ **1.1 Overview**
- ◆ **1.2 Package Checklist**
- ◆ **1.3 Product Features**
- ◆ **1.4 Product Specifications**

1.1 Overview

Thanks for purchasing SUNIX Universal PCI Multi-Port Communication Board; it is compatible with RS-232.V24 standard serial interfaces. User can expand Multi RS-232 ports on PC-based system by installing in PCI or PCI-X slots. Each port has on-chip hardware and software flow control, a built-in 128-byte Tx/Rx FIFO, and WHQL certificated device drivers. This board is designed with SUNIX 16C950 UART controller and as well built with many of SUNIX advanced features and technologies, making it the best solution for commercial and industrial automation applications.

1.2 Package Checklist

Please check if the following items are present and in good condition upon opening your package. Contact your vendor if any item is damaged or missing.

1. Hardware:

Serial Communication Board:

RS-232 Universal PCI Multi-Port Communication Board × 1

Cable: (Depend on what product you bought)

* 4 ports series: DB44M to 4 ports DB9/25 Male Cable × 1

* 8 ports series: DB62M to 8 ports DB9/25 Male Cable × 1

2. CD Driver

3. Quick Installation Guide

4. User's Manual (This document)

1.3 Product Features

- Expands Multi RS-232 serial ports on the system
- High performance SUNIX 16C950 compatible UART controller on-board.
- Ultra low power consumption design for Green Environment.
- Compliance with PCI 33MHz Version 3.0/2.3/2.2/2.1 specification.
- Supports both 64-bit PCI-X & 32-bit PCI bus slot.
- Data transmission speeds up to 115.2Kbps (921.6Kbps Optional).
- On-chip hardware auto flow control to guarantee no data loss.
- Built-in ± 2 KV ESD protection for all serial signals. (± 15 KV ESD Optional)
- Plug-n-Play, I/O address and IRQ assigned by BIOS.
- Certified by CE, FCC, RoHS, and Microsoft WHQL approval.
- Support Microsoft Windows, Linux, and DOS.

Note:

SUNIX High Speed RS-232 Card (**H** Version) supports ± 15 KV ESD protection for each signal and 921.6Kbps baud rate setting. Please refer to the Chapter 5 Appendix, Product Family for detail.

1.4 Product Specifications

Serial Communication

Interface	RS-232	Signal	TxD, RxD, RTS, CTS, DTR, DSR, DCD, RI, GND
Controller	SUNIX SUN1999 (16C950 UART Compatible)	Baud rate	50bps ~115.2Kbps (921.6Kpbs Optional)
BUS	Universal PCI 64/32bit PCI Spec.Ver3.0/2.3/2.2/2.1	Stop bit	1, 1.5, 2
No. of Port	1/2/4/8/16-port (Product Dependent)	Parity	even, odd, none, mark, space
IRQ & IO	Assigned by System	Flow Control	None, Xon/Xoff, RTS/CTS
FIFO	128byte Hardware	Connector	DB9 / 25 Male
Protection	±2KV ESD protection for each signal Human Body Model (HBM) (±15KV ESD Optional)		

Driver Support

Windows Client	XP / Vista / 7 / 8.x / 10 (X86/X64)
Windows Server	2003 / 2008 / 2012 / 2016 (X64)
Microsoft Embedded	XP Embedded / POS Ready / Embedded System
Linux	Linux 2.x / 3.x / 4.x
DOS	DOS
FreeBSD	FreeBSD 5.3~5.5 / 6.0~6.4
QNX	QNX 6.3.2 / 6.4.0
IBM OS/2*	WARP 3 / WARP 4
SCO UnixWare*	UnixWare 7.1.3 / 7.1.4 Open Server 5.0.7 / 6.0
Sun Microsystems*	Solaris 10
<i>Note : “ * “ Supported by special inquiry.</i>	

Regulatory Approvals

Hardware	EN55022 Class B, EN55024, EN61000-3-2, EN61000-3-3, FCC Part 15 Class B, RoHS
Software	Microsoft WHQL Windows Microsoft Client: XP / Vista / 7 / 8.x / 10 (X86/X64) Microsoft Server: 2003 / 2008 / 2012 / 2016 (X64)

Environment

Operation Temperature	0 to 60° C (32 to 140° F)
Operation Humidity	5 to 95% RH
Storage Temperature	-20 to 85° C (-4 to 185° F)

2.

Hardware Installation

This chapter includes information about hardware installation for RS-232 Universal PCI Multi-Port Communication Board. The following topics are covered:

- ◆ **2.1 Hardware Installation**
- ◆ **2.2 Pin Assignments**

2.1 Hardware Installation

The hardware installation of PCI serial boards is easy to carry out. Before inserting the card into the PCI bus, please follow the detailed steps given below to install the PCI serial board in your computer.



Safety First

To avoid damaging your system and boards, make sure your PC's power is turned off before installing PCI card.

Step 1: Turn your PC's power off, and shut off the power to any peripheral.

Step 2: Remove the power plug from the plug socket.

Step 3: Remove the cover from the computer case.

Step 4: If fitted. Remove the metal cover plate on the rear of a free PCI slot.

Step 5: Insert Universal PCI Multi-Port Communication Board into the free PCI slot and screw it firmly on the bracket side.

Step 6: Place the cover back onto the computer.

Step 7: Insert the plug into the plug socket.

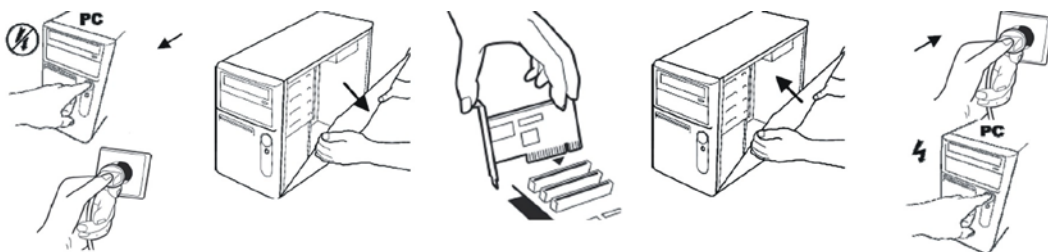

2.2 Pin Assignment

This chapter provides the pin assignments for SUNIX Universal PCI Multi-Port Communication Board, as well as the pin assignments for the optional accessories.

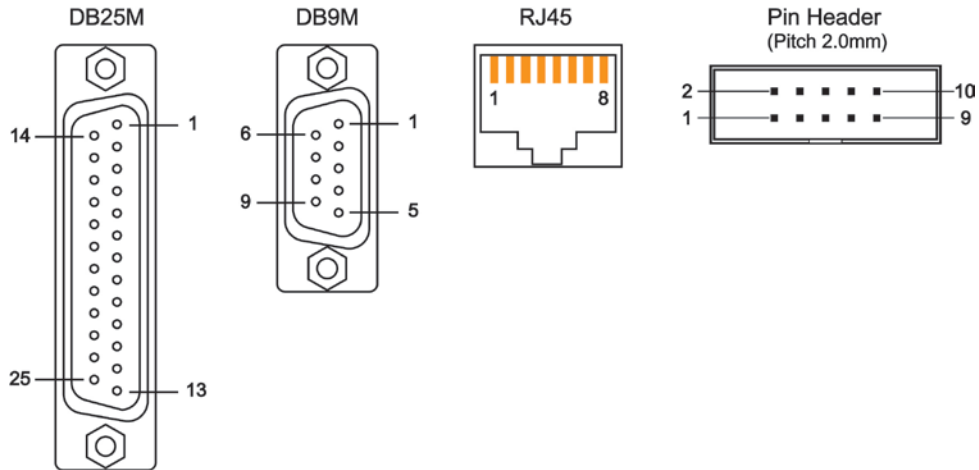

PIN	DB9M	DB25M	RJ45	Pin Header
DCD	1	8	7	1
RxD	2	3	6	3
TxD	3	2	3	5
DTR	4	20	2	7
GND	5	7	4	9
DSR	6	6	8	2
RTS	7	4	1	4
CTS	8	5	5	6
RI	9	22	-	8

Note:

8-port RS-232 card product series does not build the 9th pin RI signal.

SUNIX 2-port RS-232 Low Profile Card builds DB44F connector on board.

SUNIX DB44 Female 2 ports Serial Communication Boards Pin Assignment				
RS-232	Port	1	2	
	Signal			
	TxD	11	15	
	RxD	40	44	
	RTS	10	14	
	CTS	39	43	
	DSR	38	42	
	GND	25	29	
	DCD	26	30	
	DTR	9	13	
RI	24	28		

SUNIX 4-port RS-232 Card builds DB44F connector on board.

SUNIX DB44 Female 4 ports Serial Communication Boards Pin Assignment						
RS-232	Port	1	2	3	4	
	Signal					
	TxD	3	7	11	15	
	RxD	32	36	40	44	
	RTS	2	6	10	14	
	CTS	31	35	39	43	
	DSR	18	34	38	42	
	GND	4	21	25	29	
	DCD	17	22	26	30	
	DTR	1	5	9	13	
RI	16	20	24	28		

SUNIX 8-port RS-232 Card builds DB62F connector on board.

SUNIX DB62 Female 8 ports Serial Communication Boards Pin Assignment									
RS-232	Port	1	2	3	4	5	6	7	8
	Signal								
	DCD	24	45	8	50	11	55	58	21
	RxD	44	47	49	52	54	57	60	62
	TxD	23	26	28	31	34	36	39	41
	DTR	2	5	7	10	13	15	18	20
	DSR	1	4	6	9	12	14	17	19
	RTS	22	25	27	30	33	35	38	40
	CTS	43	46	48	51	53	56	59	61
GND	GND	GND	GND	GND	GND	GND	GND	GND	

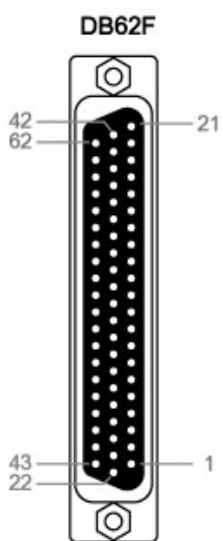

SUNIX 8-port RS-232 Low Profile Card builds DB68F connector on board.

SUNIX DB68 Female 8 ports Serial Communication Boards Pin Assignment									
RS-232	Port	1	2	3	4	5	6	7	8
	Signal								
	TxD	6	15	24	33	63	54	45	36
	RxD	3	12	21	30	66	57	48	39
	RTS	7	16	25	34	62	53	44	35
	CTS	4	13	22	31	65	56	47	38
	DSR	2	11	20	29	67	58	49	40
	GND	8	9	26	27	61	60	43	42
	DCD	1	10	19	28	68	59	50	41
DTR	5	14	23	32	64	55	46	37	
RI	-	-	-	-	-	-	-	-	-

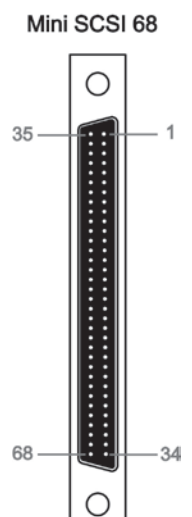

3.

Driver Installation

After installing the RS-232 Universal PCI Multi-Port Communication Board in your system successfully, please follow the step by step software installation guide to confirm how to install appropriate driver and configure the serial port settings.

The driver for PCI serial board supports Windows and Linux operating systems, and you can select your requirement in the following chapter:

The following topics covered in this chapter:

- ◆ **3.1 Windows Driver Installation**
- ◆ **3.2 Windows Driver Uninstallation**
- ◆ **3.3 Linux Driver Installation**
- ◆ **3.4 Verify Installation**

3.1 Windows Driver Installation

Please refer to following instructions to install the driver for the first time under Windows operation system. You will need to plug the board in an available PCI or PCI-X slot first, before installing the driver.

- (1) After the board is physically installed and the PC boots up, system will detect the PCI Serial card and prompt for driver installation wizard, please choose cancel.
- (2) Put CD driver bound with product in your CD / DVD ROM drive. Please select autorun.exe., then select **“Driver Installation”**.

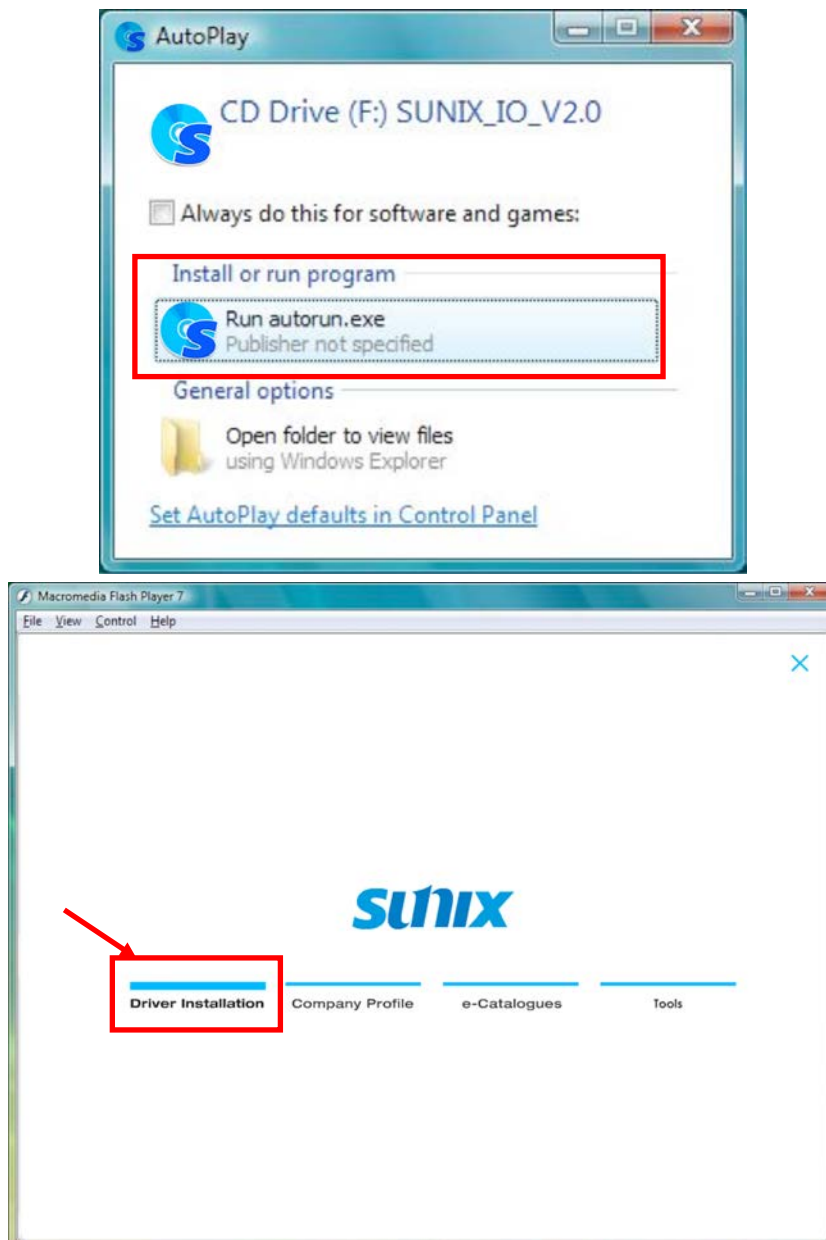

(3) Please select the product interface you bought, such as PCI.



(4) Please select the O.S. version you are using, such as Windows 8. Then system will process the driver installation step automatically.

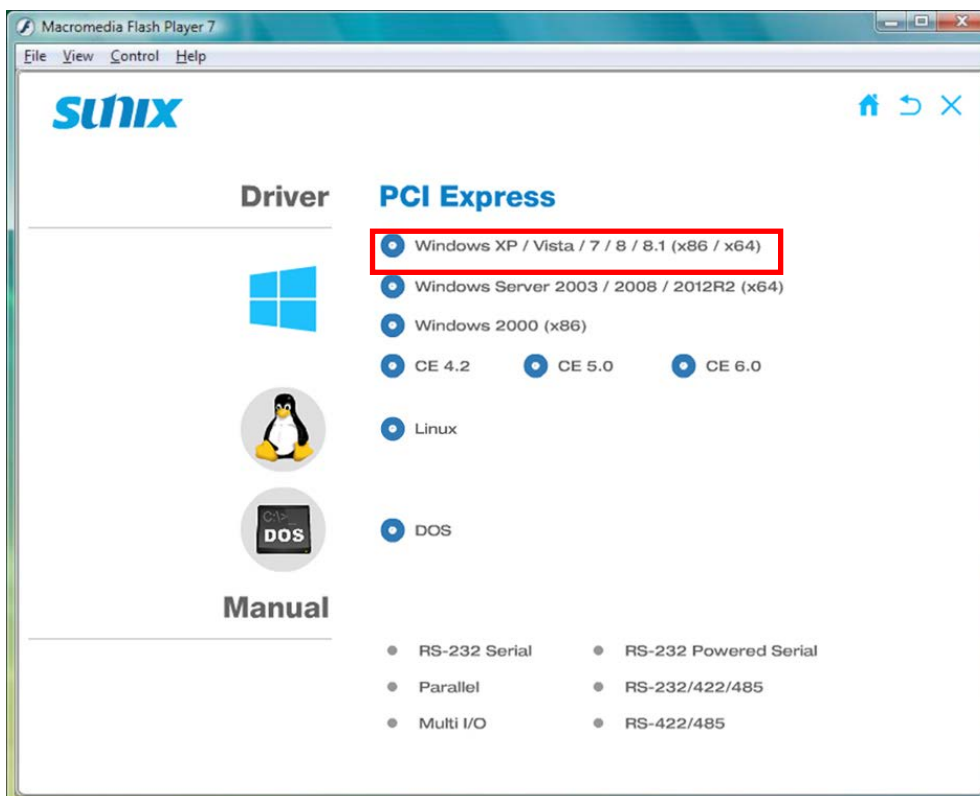

(5) Please select driver language for your operation system.

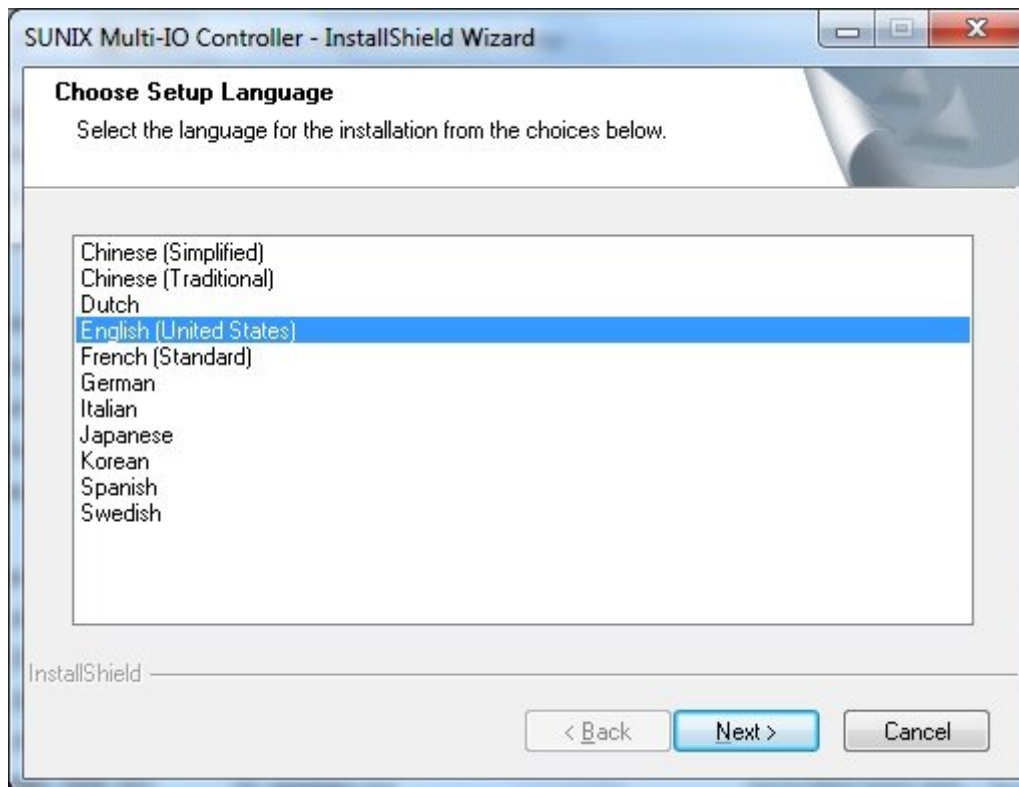

(6) Click “**Next**” to continue driver installation steps.

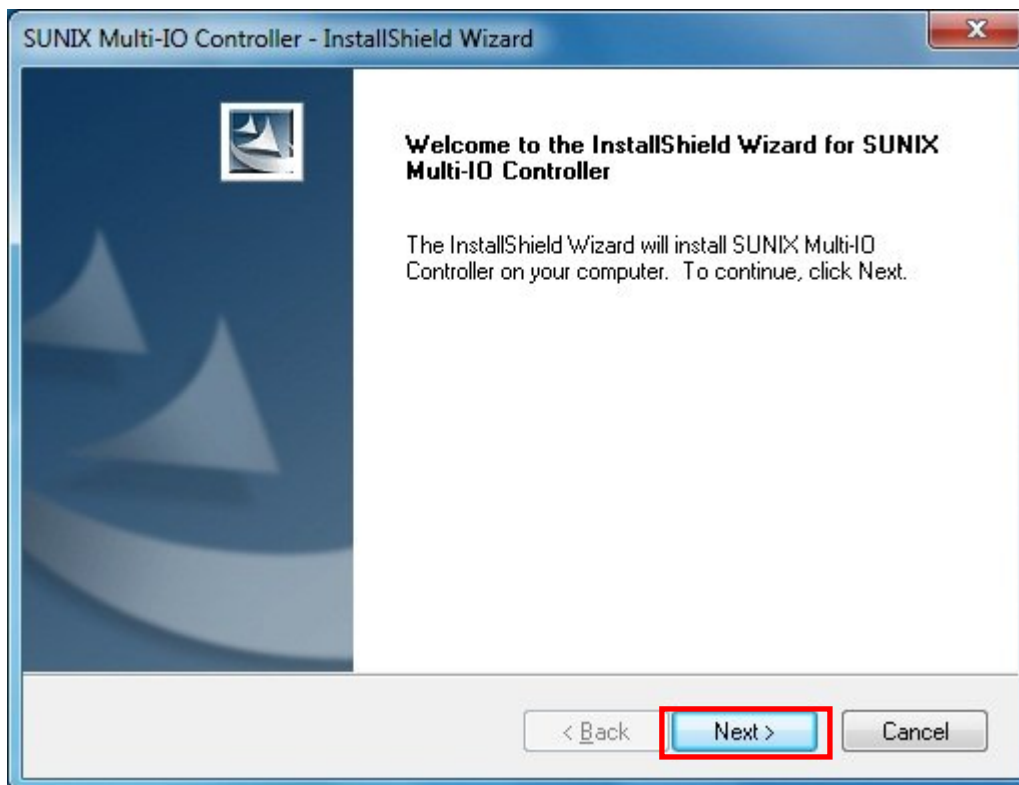

(7) Click **“Install”** to continue driver installation steps.

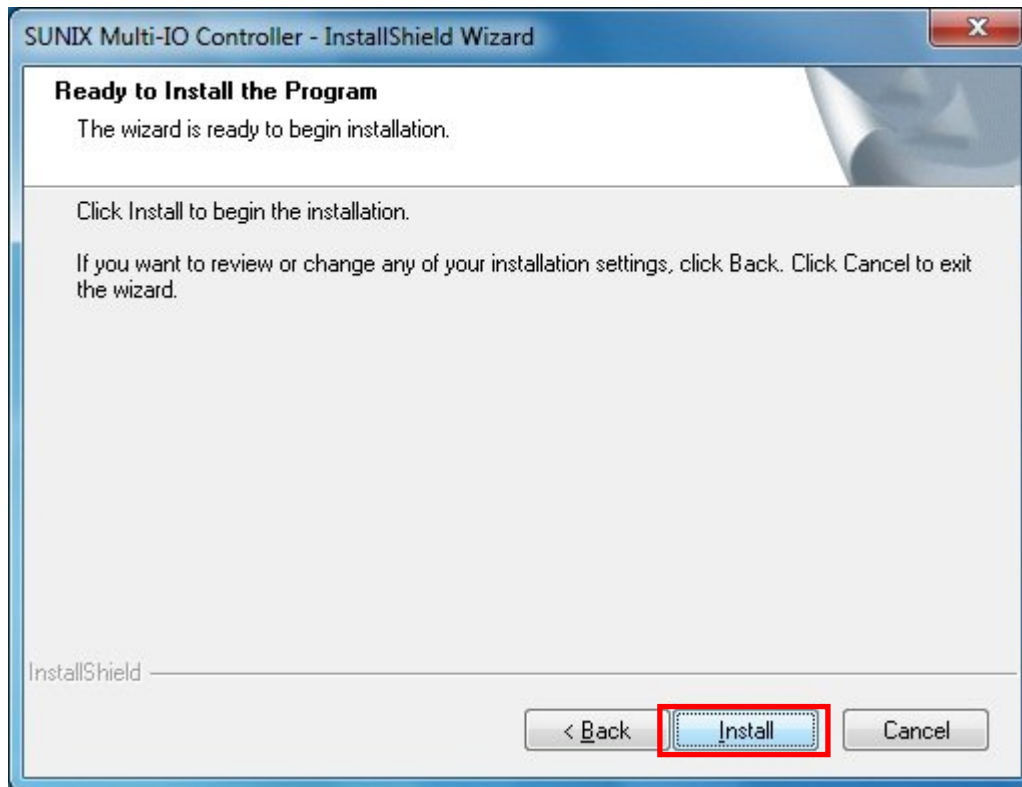

(8) System will install driver automatically. It takes about one minute.

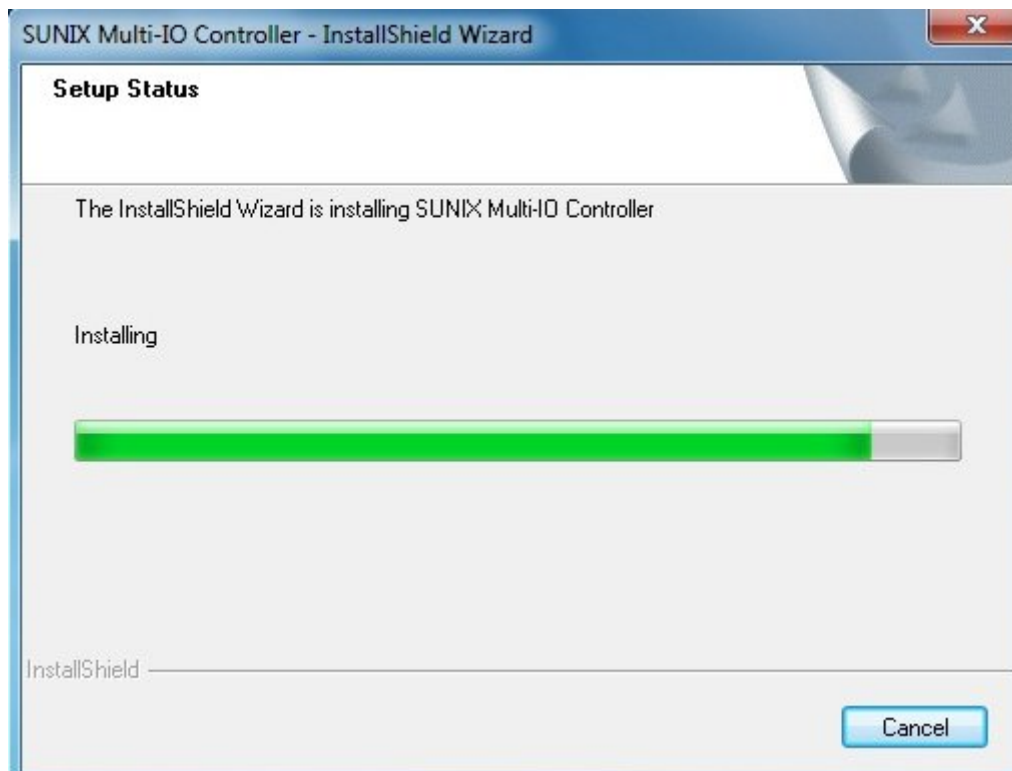

(9) Click “**Finish**” to end installation steps.

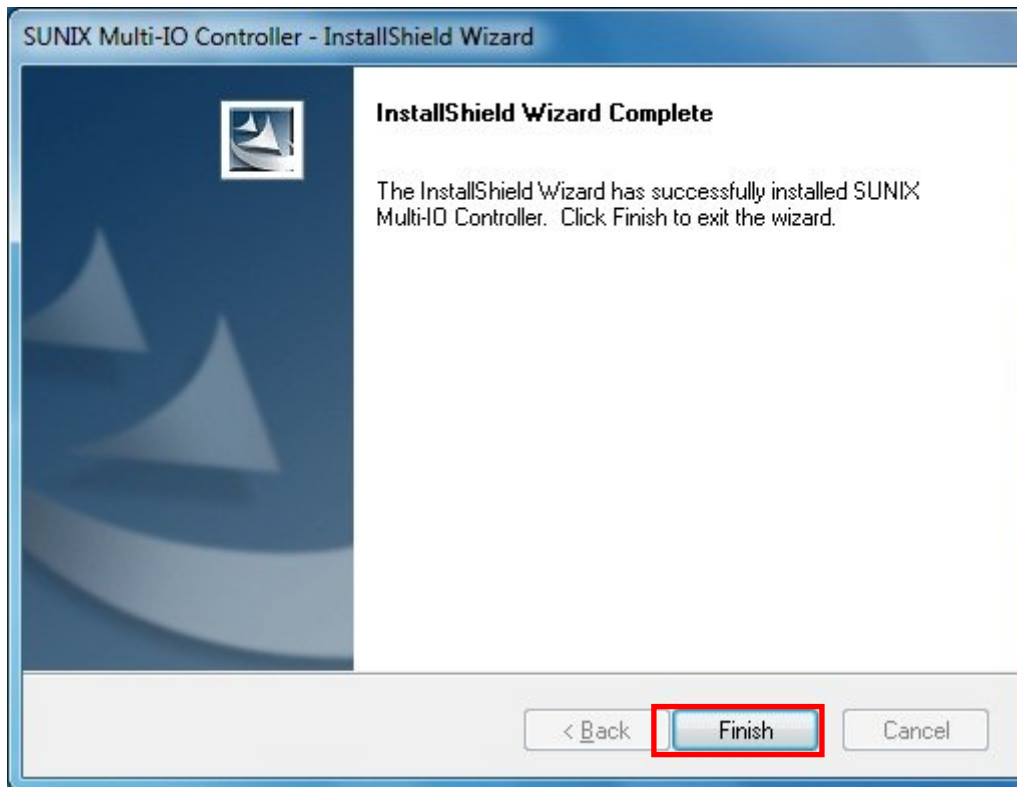

3.2 Windows Driver Uninstallation

Please refer to following instructions uninstall Multi-I/O card driver.

- (1) Click on the “**Programs and Features**” tab in the Windows Control Panel.

Start > Controller Panel > Programs and Features

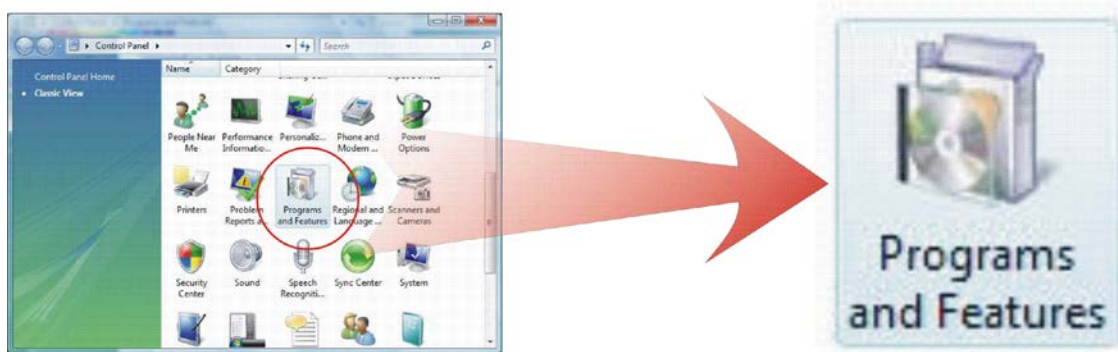

- (2) Entry Uninstall or change a program page, and double click “**Windows Driver Package – SUNIX Co., Ltd SUNIX Multi-I/O Controller**” to process driver uninstallation procedure.

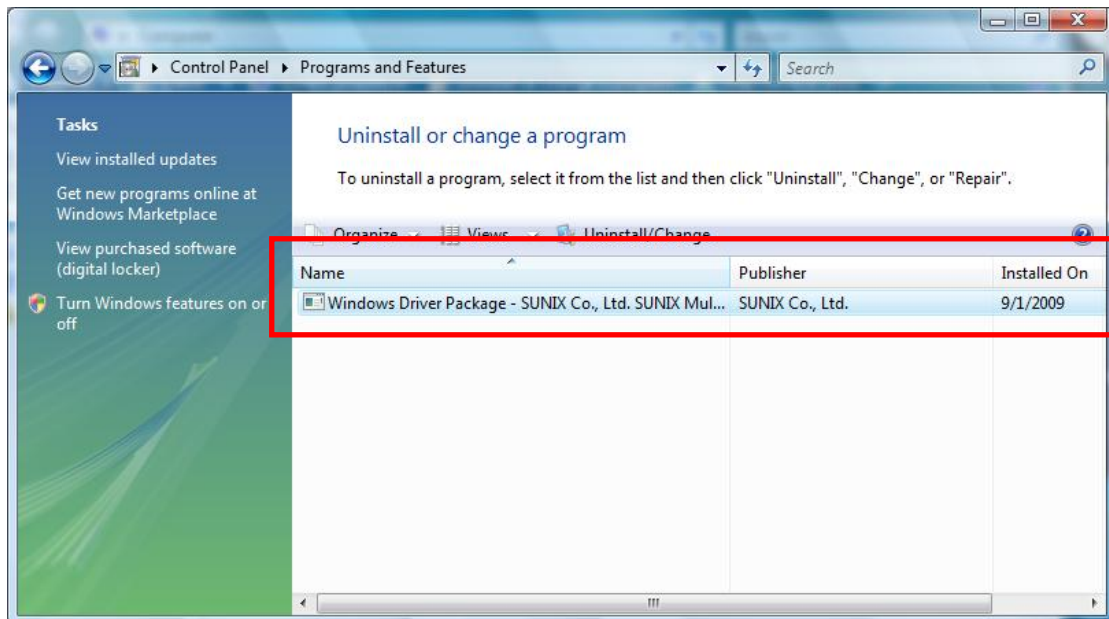

3.3 Linux Driver Installation

This installation guide describes the procedures to install the PCI serial board in Linux kernel 2.x, 3.x and 4.x Please refer to "snx_Vx.x.x.x.zip" for driver installation detail in CD Driver (Linux folder) directory.

: \PCI_IO \Linux

(1) Driver install

Please create a directory under root directory, e.g /temp, do commands:

```
# cd /  
# mkdir temp
```

After get driver file "snx_Vx.x.x.x.zip". Copy file to /temp directory, then extract and install, do commands:

```
# cp snx_Vx.x.x.x.zip /temp  
# cd /temp  
# unzip snx_Vx.x.x.x.zip  
# cd /temp/snx  
# make clean ; make install
```

* If system is Suse 9.0 and errors occur when

* "make clean ; make install", do commands:

*

* # cd /usr/src/linux/

* # make cloneconfig

* # make dep

*

* then do "make clean ; make install" again in /temp/snx

Load driver module, do command:

```
# modprobe snx  
or  
# insmod /temp/snx/driver/snx.ko (snx.o for kernel 2.4)
```

Check driver module, do command:

```
# lsmod | grep snx
```

Unload driver, do command:

```
# rmmod snx
```

(2) Device node creation

Each serial port has one device node which is named "ttySNX?", maximum up to 32 serial ports.

This setp will be done when do "make clean ; make install", if device nodes aren't in /dev, do commands:

```
# cd /temp/snx/snxmknod  
# ./snxmknod
```

This will create device nodes in /dev.

If there are more than two boards installed, serial port device nameing convention please refer to F1.

3.4 Verify Installation

You can use Windows “**Device Manager**” to verify proper installation.

(1) Click on the “**Programs and Features**” tab in the Windows Control Panel.

Start > Controller Panel > Device Manager

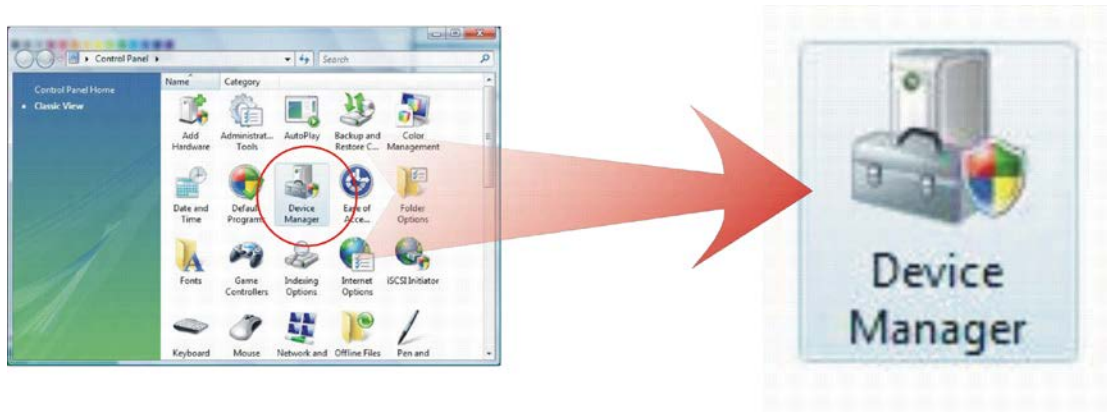

(2) In the Device Manager window, you should see this board under **Multifunction adapters** (4-port RS-232 Serial Card in this example). You should also see SUNIX COM port under **Ports (COM & LPT)**.

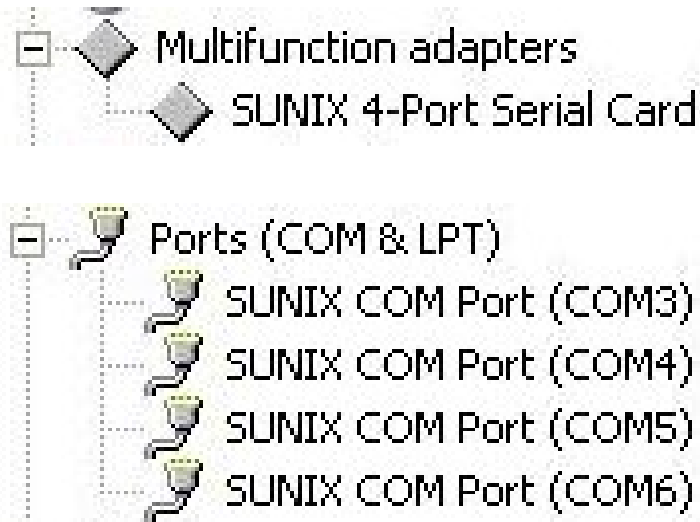

4.

Port Configuration

This chapter shows all Serial COM port settings that user came with usually, such as COM port number, FIFO length(size), baud rate, IO address and others.

The following topics covered in this chapter:

- ◆ **4.1 Configure Serial Port Settings**
- ◆ **4.2 COM Port Number Settings**
- ◆ **4.3 COM I/O Resource**
- ◆ **4.4 FIFO Settings**
- ◆ **4.5 Advanced Settings**

4.1 Configure Serial Port Settings

After the board and serial port drivers are installed, please refer to following instructions to configure Serial COM settings.

- (1) Please launch the “**Device Manager**”.
- (2) Right click the “**SUNIX Serial Card**” item from the “**Multifunction adapters**” sub-tree and click “**Properties**”.

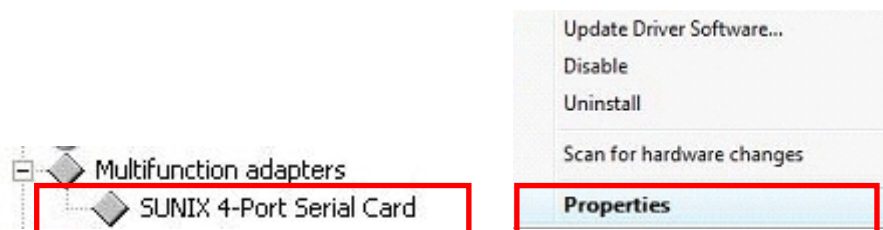

- (3) On the “**Port Control**” tab, select a port to configure.
 - * Click “**OK**” to approve the settings for the selected port.
 - * Click “**Set to All**” to approve the settings for all COM ports.

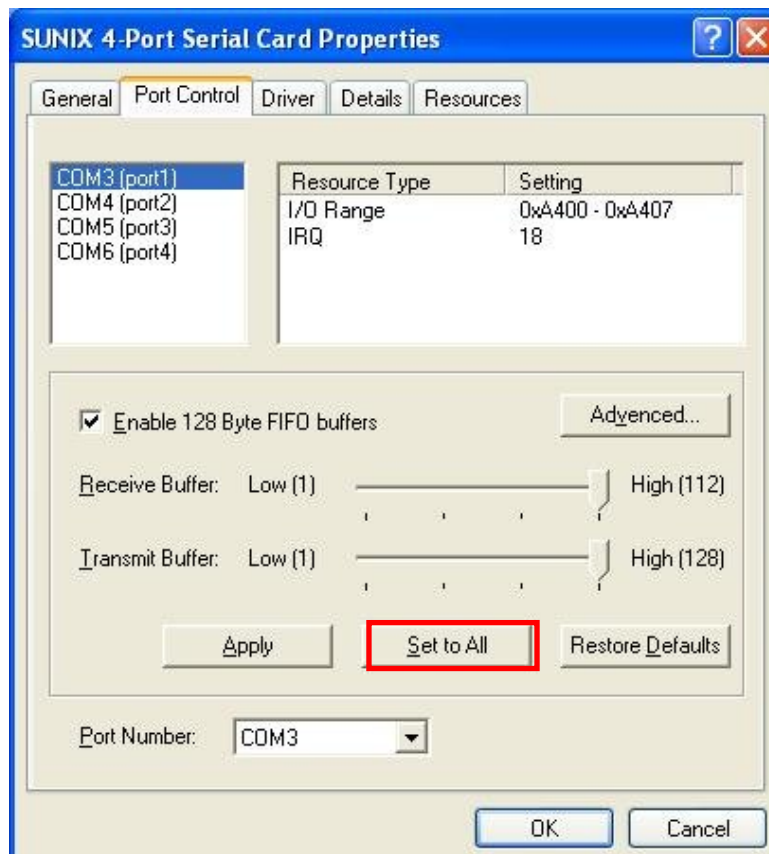

4.2 COM Port Number Settings

Under Port Number, select a COM number to assign to the serial port. Click “OK” to approve the settings for the selected port.

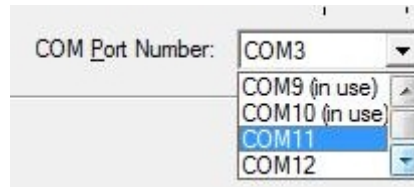

Note: In order to prevent system resource conflict, do not select “in use” port.

4.3 COM I/O Resource

User can read the COM “IO Range” and “IRQ” located in system by selecting COM port.

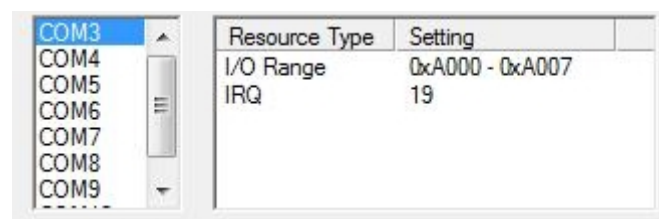

IRQ and I/O address is automatically assigned by the mainboard PCI BIOS automatically (before COM card driver installing). User can NOT assign legacy ISA address (3F8, 3E8, 2F8, 2E8) for the specific COM port. But for IRQ setting, user can set specific IRQ value for this PCI bus slot via mainboard’s BIOS settings (not via SUNIX driver). But all COM ports will share one IRQ value.

4.4 FIFO Settings

Select an Rx FIFO Trigger and Tx FIFO Size.

The default Rx FIFO Trigger is 112 bytes. The default Tx FIFO Size is 128 bytes. Click **“Set to All”** to change this setting for all serial ports on the board. Then click **“OK”** to save the settings.

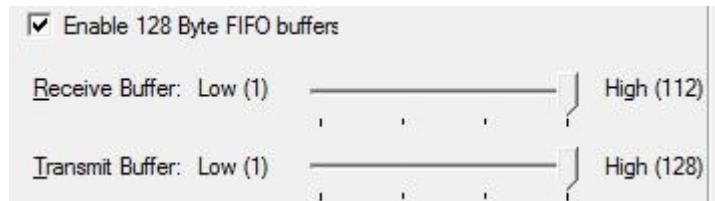

Receive FIFO interrupt trigger level:

When the level of data in the receiver FIFO reaches this value, a receiver data interrupt is triggered.

Transmit FIFO interrupt trigger level:

When the level of data in the transmit FIFO falls below this value, a transmitter interrupt is triggered. Setting this value to zero will not trigger an interrupt until the transmitter is completely idle.

The FIFO trigger levels can be fine-tuned to gain optimum performance, depending on system performance, baud rate used, levels of serial traffic etc.

4.5 Advanced Settings

User can control RS-232 communication in Advanced Port Control page through “**Advanced**” settings.

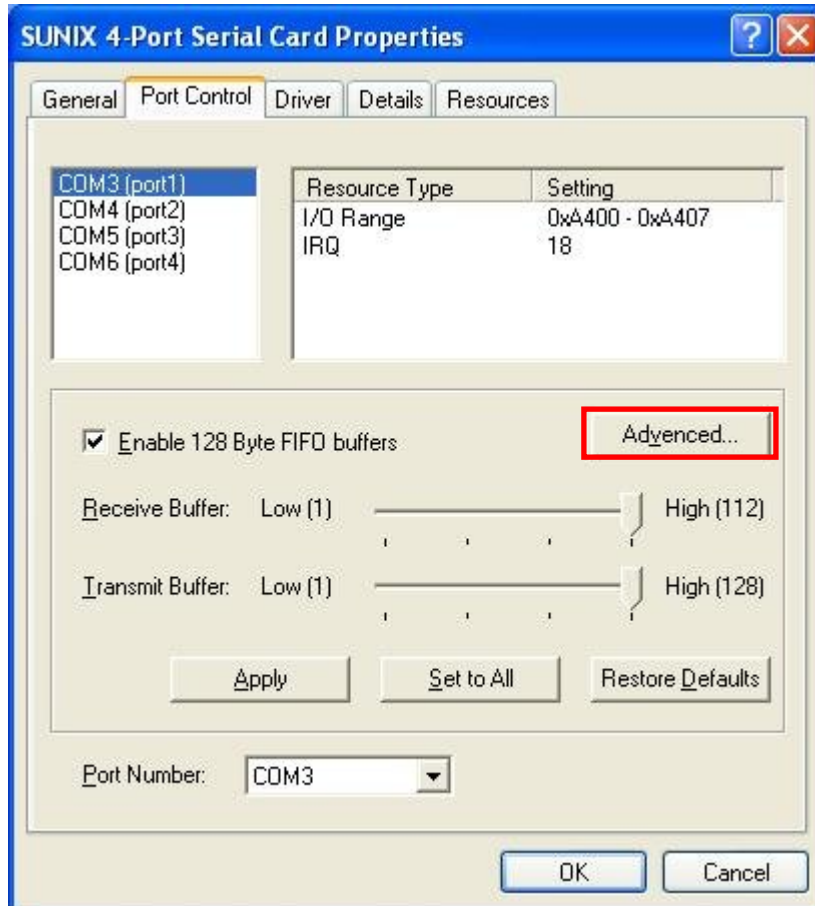

Clock Rate

This is the “Data Rate” value for on board crystal frequency of input clock. The baud rate can optionally be adjusted according to the data rate required. The clock pre-divisor is used to divide the input clock prior to baud rate generation.

This parameter must match with the oscillator (crystal) frequency on the board. System default is **14745600 Hz**. We do NOT recommend for modification without SUNIX instruction. User can click “**Defaults**” button back to manufactory settings.



5.

Appendix

This chapter shows some problems that user came with usually. Also you can check it if the PCI serial board can not work properly in your system after following hardware and software installation steps. In addition, you could contact with us for detail technical product information.

In this appendix, we cover the following topics.

- ◆ **5.1 Troubleshooting**
- ◆ **5.2 Product Family**
- ◆ **5.3 Contact Information**

5.1 Troubleshooting

1. System fails to find the PCI serial board or COM port.

A: It may cause by following issue:

- a. The board is not properly plugged into the PCI slot.
- b. Please clean the golden finger.
- c. The PCI slot is defective. Please try other slots until you find one that works.
- d. The mainboard does not have an available IRQ for the PCI serial board. Enter the PC.s BIOS and make sure an IRQ setting is available in the PCI/PnP settings.
- e. The board itself might be defective. You can try another mainboard testing this board working or not.

2. There is a blue screen when I entry operation system.

- A:**
- a. The possible reason is an IRQ or I/O address conflict with other PCI bus adapters, such as LAN or serial boards, or with the system BIOS. Refer to the corresponding problem in the previous FAQ for solutions.
 - b. Please check driver update from your vendor.

3. There are some exclamation marks in device manager and serial ports can not work properly.

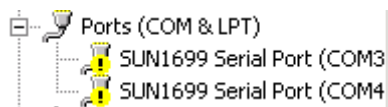

- A:**
- a. It caused by the wrong driver installing or hardware settings. Please turn off your computer firstly and re-install hardware and software, especially re-install the correct driver.
 - b. Please update driver manually by specifying driver INF file folder.

4. Should I enable auto flow control features?

- A:** Enable Auto CTS/RTS Flow Control means the CTS/RTS flow control is controlled by hardware automatically. System will be more stable if the function is enabled. Please make sure your serial device and cable wiring before enabling the hardware flow control function.

5. How large FIFO length I should set?

A: FIFO (First-in-First-out) buffers are used to reduce the frequency of interrupt processes for UART chips. The size of the buffer will determine the number of times the cards need to interrupt the computer's CPU in order to process a string of data. With larger FIFO buffer size; there is more data flow and less interruption to the CPU, therefore allowing the CPU to be free to handle other more crucial tasks.

Set the Receive/Transmit Buffer to higher value will get faster performance because the interrupts will be reduced, but the time for interrupt service routine will become shorter. The receive buffer overflow will be easily happened if the CPU speed is not enough to handle. If the system is not stable, select the lower value to correct problems.

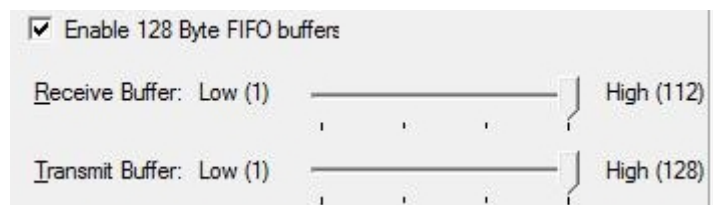

5.2 Product Family

SUNIX provides kinds of RS-232/422/485 interface cards for customer selection, including PCI Express, PCI and PCI/104 card. Please refer to the product family table for reference.

RS-232 PCI Express Interface						
Port	Connecter	Baud Rate	ESD Protection	Power output	Bracket	Model NO.
16	Mini SCSI 68 Female	921.6Kbps	± 15KV	-	Standard	SER5416H
8	DB62 Female	115.2 kbps		-	Standard	SER5466A
				-	Low profile	SER5466AL
	Mini SCSI 68 Female	921.6Kbps		-	Standard	SER5466H
				-	Low profile	SER5466HL
4	DB44 Female	115.2 kbps		-	Standard	SER6456A
				5V/12V		SER6456P
				-	Low profile	SER6456AL
				5V/12V		SER6456PL
	921.6Kbps	-		Standard	SER6456H	
		5V/12V			SER6456PH	
		-		Low profile	SER6456HL	
		5V/12V			SER6456PHL	
2	DB9 Male	115.2 kbps		-	Standard	SER6437A
				5V/12V		SER6437P
	DB44 Female	-		Low profile	SER6437AL	
		5V/12V			SER6437PL	
	DB9 Male	921.6Kbps		-	Standard	SER6437H
				5V/12V		SER6437PH
	DB44 Female			-	Low profile	SER6437HL
				5V/12V		SER6437PHL
	5x2 Pin Header	-			SER6437UHL	

RS-232 PCI Interface						
Port	Connecter	Baud Rate	ESD Protection	Power output	Bracket	Model NO.
8	Mini SCSI 68	921.6Kbps	± 15KV	-	Standard	SER5016H
	DB62 Female	115.2Kbps	± 2KV	-	Standard	SER5066A
	Mini SCSI 68			-	Low profile	SER5066AL
	5x2 Pin Header			-	Standard	SER5066U
	5x2 Pin Header			-	Low profile	SER5066UL
	DB62 Female	921.6Kbps	± 15KV	-	Standard	SER5066H
	Mini SCSI 68			-	Low profile	SER5066HL
	5x2 Pin Header			-	Standard	SER5066UH
5x2 Pin Header	-			Low profile	SER5066UHL	
4	DB44 Female	115.2Kbps	± 2KV	-	Standard	SER5056A
				5V/12V		SER5056P
				-	Low profile	SER5056AL
				5V/12V		SER5056PL
	5x2 Pin Header	921.6Kbps	± 15KV	-	Standard	SER5056U
				-	Low profile	SER5056UL
	DB44 Female	921.6Kbps	± 15KV	-	Standard	SER5056H
				-	Low profile	SER5056HL
				5V/12V	Standard	SER5056PH
				-		SER5056UH
	5x2 Pin Header	-	Low profile	SER5056UHL		
	DB44 Female	5V/12V		SER5056PHL		
2	DB9 Male	115.2Kbps	± 2KV	-	Standard	SER5037A
				5V/12V		SER5037P
	5x2 Pin Header			-	Low profile	SER5037U
	DB44 Female			5V/12V		SER5037AL
	5x2 Pin Header	-	SER5037UL			
	DB9 Male	921.6Kbps	± 15KV	-	Standard	SER5037H
				5V/12V		SER5037PH
				5x2 Pin Header	-	Low profile
DB44 Female				5V/12V	SER5037HL	
5x2 Pin Header	-	SER5037PHL				
5x2 Pin Header	-	SER5037UHL				
1	DB9 Male	115.2Kbps	± 2KV	-	Standard	SER5027A
				5V/12V		SER5027P
				-	Low profile	SER5027AL
				5V/12V		SER5027PL
	921.6Kbps	± 15KV	-	Standard	SER5027H	
			5V/12V		SER5027PH	
			-	Low profile	SER5027HL	
			5V/12V		SER5027PHL	

RS-232 PCI/104 Interface				
Port	Connecter	Baud Rate	ESD Protection	Model NO.
8	5x2 Pin Header	115.2Kbps	±2KV	SER5337A
4				SER5356A
2				SER5366A

RS-422/485 PCI Express Interface						
Port	Connecter	Baud Rate	ESD Protection	Surge Protection	Isolation Protection	Model NO.
8	DB44 Female	921.6Kbps	±15KV	600W	2.5KV	IPC-E2108SI
				600W	-	IPC-E2108S
4	DB44 Female	921.6Kbps	±15KV	600W	2.5KV	IPC-E2204SI
				600W	-	IPC-E2204S
2	DB9 Male	921.6Kbps	±15KV	600W	2.5KV	IPC-E2202SI
				600W	-	IPC-E2202S

RS-422/485 PCI Interface						
Port	Connecter	Baud Rate	ESD Protection	Surge Protection	Isolation Protection	Model NO.
16	DB78 Female	921.6Kbps	±15KV	-	-	IPC-P2116
8	DB44 Female	921.6Kbps	±15KV	600W	2.5KV	IPC-P2108SI
				-	-	IPC-P2108
4	DB44 Female	921.6Kbps	±15KV	600W	2.5KV	IPC-P2104SI
				-	-	IPC-P2104
2	DB9 Male	921.6Kbps	±15KV	600W	2.5KV	IPC-P2102SI
				-	-	IPC-P2102

RS-422/485 PCI/104 Interface						
Port	Connecter	Baud Rate	ESD Protection	Surge Protection	Isolation Protection	Model NO.
8	5x2 Pin Header	921.6Kbps	±15KV	600W	2.5KV	IPC-B2108SI
				-	-	IPC-B2108
4	5x2 Pin Header	921.6Kbps	±15KV	600W	2.5KV	IPC-B2104SI
				-	-	IPC-B2104
2	5x2 Pin Header	921.6Kbps	±15KV	600W	2.5KV	IPC-B2102SI
				-	-	IPC-B2102

RS-232/422/485 PCI Express Interface						
Port	Connecter	Baud Rate	ESD Protection	Surge Protection	Isolation Protection	Model NO.
8	DB44 Female	921.6Kbps	±15KV	-	-	IPC-E3108
4	DB44 Female	921.6Kbps	±15KV	600W	-	IPC-E3204S

RS-232/422/485 PCI Interface						
Port	Connecter	Baud Rate	ESD Protection	Surge Protection	Isolation Protection	Model NO.
8	DB44 Female	921.6Kbps	±15KV	-	-	IPC-P3108
4	DB44 Female	921.6Kbps	±15KV	-	-	IPC-P3104

5.3 Contact Information

Customer satisfaction is our number one concern, and to ensure that customers receive the full benefit of our products, SUNIX services has been set up to provide technical support, driver updates, product information, and user's manual updates.

The following services are provided

E-mail for technical support

..... info@sunix.com

World Wide Web (WWW) Site for product information:

..... <http://www.sunix.com>